

Article number: 205345450M8E

Description: E+G Three-star knobs - GN 5345.4-50-M8-E

Measures

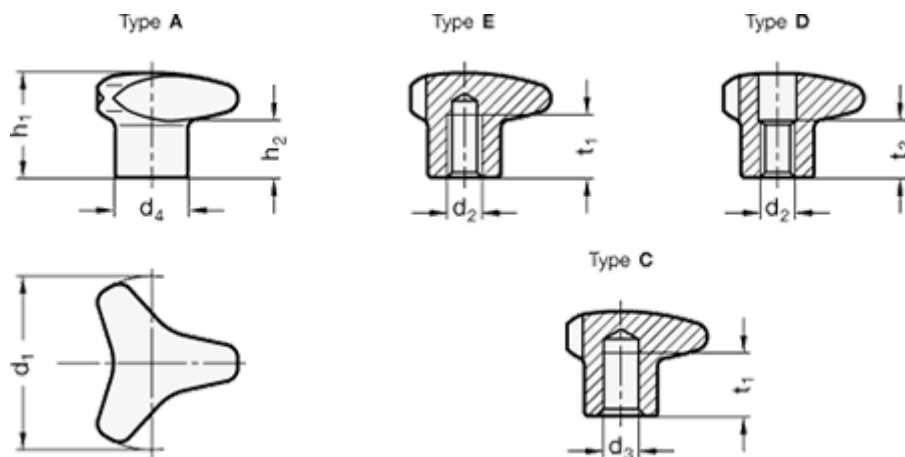

d1 = 50
d2 = M8
d3 H7 = -
d4 = -
h1 = 30
h2 = 17
t1 min. = 15
t2 = -

Weight (g) = 109